



## **Energy and raw material savings in foundries through thorough utilization of simulation**

Jörg C. Sturm, MAGMA Giessereitechnologie GmbH, Aachen Germany

Christof Heisser, MAGMA Foundry Technologies, Inc., Schaumburg/IL USA

### **Abstract**

Foundries are “world champions“ in effectively recycling their materials. More than 90% of all cast parts are made from re-melted scrap metal. But it doesn't stop with the metal: molding materials (sand) and water are efficiently re-used, leading to almost no waste.

Nevertheless, the costs for energy and materials in foundries are in average responsible for 40% of all costs – as high as expenditures for personnel. Melting and solidifying metals require a high amount of energy. Physical laws determine an average energy input of 2,000 kWh per metric ton of final casting product. This adds up to a total energy consumption of 11 billion kWh of the German foundry industry

per year. Over 50% of this energy is not used for the final casting itself, but is used for gating and risering systems, which are necessary to route the metal to and into the cavities that later contain the final castings. The gating and riser system also provides material to the casting during the solidification process to counteract the volume difference between the liquid and solid state of the metal, thereby eliminating shrinkage defects.

It is exactly here, where casting process simulation provides an indispensable contribution: simulation allows the foundry engineer to design a gating and riser system at the physical and technological optimum before the first casting is poured. It achieves energy savings in two ways: firstly through minimization of the needed amount of material and, secondly, through the related reduction in energy use for the melting process.

Additional important contributions of simulation regarding energy efficiency and the related CO<sub>2</sub>-emission reduction are found in the reduction of the process and cycle times in the production of high production castings. It is used to optimize the necessary heat-up process and temperature distribution of permanent molds, as well as finding the pattern layout with the maximum numbers of parts. Throughout the entire production, simulation is also reducing energy consumption, as it is used to reduce the amount of molding material, improve shakeout conditions, and eliminate cleaning and rework including repair welding. Significant indirect energy savings are accomplished by reducing or eliminating trial and error runs prior to the final production run.

Therefore, the energy and raw material efficiency of a foundry can be significantly improved through the utilization of casting process simulation. The following examples from foundries will demonstrate how simulation contributes solutions to questions raised in the current CO<sub>2</sub>-Discussion.

## Introduction

To make one metric ton of castiron, in average 1,000 kWh of electrical power and 100 kg of coke are required. This equals emissions between 1,500 und 2,000 kg CO<sub>2</sub> per metric ton of final castings [1]. The average energy input for diecastings is about 5,600 kWh per metric ton of final castings, equaling CO<sub>2</sub>-emissions of approx. 2,500 kg per metric ton [2]. In Germany 5.9 Mio Metric tons of metals are annually melted and poured (4.8 Mio metric tons of steel and castiron, 1.1 Mio metric tons of non-ferrous materials [3]). Taking these average numbers (2,000 kWh per metric ton of final castings, 563 g CO<sub>2</sub> per kWh of electric power in Germany [4]), it can be estimated that the annual energy consumption of German foundries is approx. 11 billion kWh and 6.5 Mio metric tons of CO<sub>2</sub>-emissions. It becomes clear, looking at these numbers, that energy efficient “green“ foundries can contribute a lot to climate improvement.

Naturally, the foundry industry focuses already for a long time, just due to business economical reasons, on utilizing and further developing energy saving casting processes. Energy consumption is a huge part of the production costs in foundries and, thereby, has a tremendous impact on profit margins and competitiveness. The main focus of energy reduction campaigns usually revolves around the optimization of energy related processes, i.e. the melting process and to run foundry equipment: more efficient furnaces with higher efficiencies, furnace linings with better insulating capacity, the utilization of energy recuperation or optimized distribution of pressurized air, are all part of current research programs.

**Less energy and raw material input through casting process simulation**

Casting process simulation can provide a significant contribution to an energy efficient foundry. It supports in many ways the reduction of the required amount of raw materials and the related energy consumption to process these materials. A massive amount of the energy used to produce the final casting is lost in re-melt and burn-off. If it is possible to reduce the amount of re-melt and the ratio of final casting to total pouring weight is increased (casting yield), a huge amount of energy can be saved. The Institut für Gießereitechnik IfG, Düsseldorf/Germany, has calculated that an improvement of the casting yield from 60 to 70 % can save 300,000 kWh electric power per year for a foundry producing 2,000 metric tons of castings using an induction furnace [1]. Energy consumption can be reduced additionally in the entire process chain (Table 1 and Fig. 12). Only the thorough optimization of all “energy hotspots“ leads to a reduction of CO<sub>2</sub>-emissions throughout the economy and assures foundries advantages in costs and competitiveness.

<b>Process</b>	<b>Castiron</b>	<b>Steel</b>
	kWh/t	kWh/t
Melting	944	1.000
Heat Treatment	42	514
Ladle Preparation	214	214
Molding	171	120
Cleaning	128	171

Table 1: Specific average energy consumption in castiron and steel for several process steps in foundries. Areas impacted significantly by casting process simulation in red ([1] modified).

**The analytical view into the mold**

The idea of casting process simulation as tool for energy and cost reduction was “born“ in Aachen/Germany. Already in the early 1980s the value of this approach was recognized by the German Research Consortium (Deutschen Forschungsgemeinschaft) and its fundamentals were supported within the framework of a special research area of the RWTH Aachen to promote energy and raw material savings in manufacturing processes [5].

With the introduction of casting process simulation into foundries by the end of the 1980s, it was possible for the first time to virtually look inside the “Black Box“ mold and to optimize process conditions and gating designs based on proven data. The primary goal of casting process simulation is the development of economical, cost optimized casting processes to produce casting with higher quality. This is coupled with the goal of achieving an energy and cost saving improvement of raw material utilization. The systematic use of casting process simulation during the casting and process development and in the prototype phase, which lead to the reduction of scrap and rework, provides additional cost savings. Additionally, energy savings can be achieved by improving the productivity through improved temperature distributions in permanent molds and dies, as well as successive processes like heat treatment. Simulation also provides financial benefits through the reduction of product and process development times, improved communication (internally and externally with customers), as well as the education and training of employees and transparent documentation of the corporate know-how.

Over the last 30 years casting process simulation tools in foundries have evolved from defect detection and gating development tools to an accepted methodology for the thorough improvement of efficiencies and assurance of robust processes. Naturally, this role of simulation is based on the trust foundry experts gained in the results of simulation. Therefore, the predictive description of processes is used like a „virtual test foundry“, where the casting technology is not only calculated once to confirm initial assumptions, but is used to perform parameter and sensitivity studies to detect the impact of important process parameters on the stability of the production process. This establishes the basis for the understanding of important parameters and its impact on energy and material efficiency in a foundry. The following examples depict these connections.

## Designing cost reducing castings

Weight reduction is the key technology in the automotive and equipment manufacturing industries. 100 kg of weight reduction in a vehicle equate to fuel consumption reduction of 0.2 to 0.4 l/100 km. Over the life cycle of a vehicle, with a total driven distance of 250,000 km, up to 1,000 liters of gasoline or 2.3 metric tons of CO<sub>2</sub> can be saved. Also, the equipment manufacturers need to think in lightweight terms. I.e. the increasing weight of planned wind energy nacelles of large offshore wind energy turbines becomes the critical feasibility and success factor.

Through the utilization of modern simulation tools it is possible to extract the entire potential of cast materials and their manufacturing processes. Simulation tools today are capable to exactly predict the impact of process parameters onto casting quality. They can be utilized very early in the product development process to reduce weight. The provided information from simulation programs supports not only the designer to find castable and weight optimized designs, but also the foundry engineer to establish a stable and cost effective production.

Initially, the designer creates a model to meet the load requirements. Casting process related know-how is often introduced to the design when a potential supplier becomes involved. At this point in time the design is often already frozen and any necessary change required by the casting process causes a lot of work and leads to expensive communication loops between the designer and the supplier. It has been established that 80% of all production costs are defined by the design of the casting. Especially with parts that demand special attention to lightweight related requirements, an early involvement of casting process simulation provides tremendous benefits (Figure 1). Design features that can be problematic for the casting process and related potential loss of quality can be detected early, when simulation is used, and discussed between the designer and the supplier. This is especially true for multi-step production processes where the casting process, the heat treatment process, as well as the following machining processes define the final properties of the part.

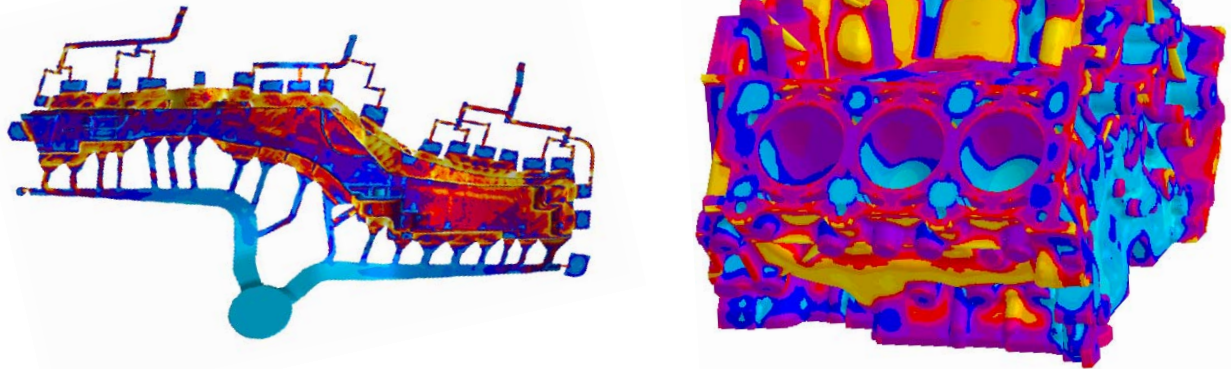

Fig. 1: Lightweight designs in castings can be achieved with all cast materials (left: Audi D4 Connector in AlSi9Mn [6], right: weight optimized Audi V6 engine block in Compacted Graphite Iron [7]).

### **Energy savings through reduction or elimination of trial and error runs**

Without casting process simulation, many expensive trial runs of the casting process need to be performed after the design of the part is finalized. Simulation almost eliminates this process of approaching the optimum process configuration through physical test pours. The foundry expert uses simulation software to establish all process parameters for a robust production prior the production start.

Just through the reduction or elimination of test runs, initial raw material and energy savings are realized right away. I.e. an American foundry has reduced the configuration and numbers of test pours so drastically that not only the costs for prototypes by themselves were reduced by US\$ 580,000.00 but the elimination of test runs that led to bad castings created additional savings of US\$208,000.00 [8].

Another example comes from a steel foundry that used casting process simulation to reduce necessary trial runs. The comparison between simulation effort and number of test runs shows a clear correlation: the intensification of simulation activities by 56% lead to the reduction of 64% in the number of trial runs (Figure 2). With the simulation aided development of the gating system of approx. 30 parts per month,

the foundry was able to reduce the overall scrap cost by 2.65 %, equaling US\$514,000.00 [9].

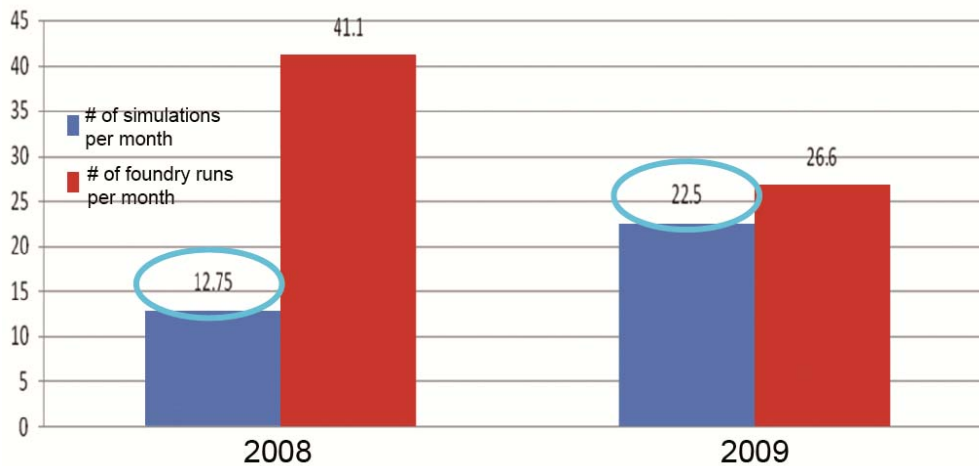

Fig. 2: Reduction of test runs vs. Number of simulations in 2009 [9].

### Introduction of new casting technology

The introduction of new casting technology in any foundry is associated with challenges and risks. The chances of increased energy and material efficiency are recognized, but weighted against the production risk and delivery promises. This leads, over and over again, to keeping the old ways of doing things.

During the production of complex ductile iron carriers a shrinkage defect was detected only late in the machining process. The first simulation showed the defect and its root cause: the feeding pass to the critical area is cut off prematurely. A change in the riser layout eliminated the defect (Figure 3). Additionally, the necessary changes to the gating system reduced the pouring weight by 13kg and shortened the pouring time by 2.5 s. The realized savings in 13 metric tons of melt per year equals energy savings in the melting process of 12,272 kWh. Another benefit was realized by reducing the riser neck cross section by 25%, leading to reduced riser removal costs. Furthermore, the modified layout leads to a reduction in the solidification time by 11 minutes and, thereby, to an increase in productivity by 15%. The original job was to eliminate the defect. The final solution, based on simulation, lead to significantly reduced production costs [10].



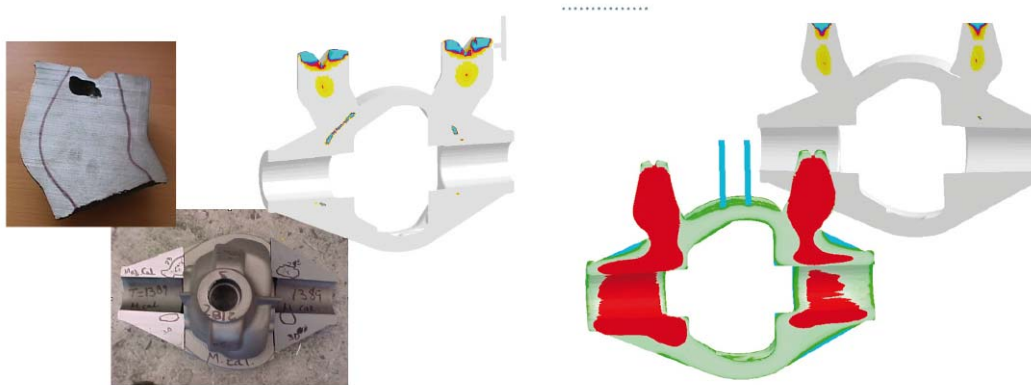

Fig. 3: The introduction of a new riser design (right) lead to a reduction in material costs, as well as melting and cleaning costs in combination with a better casting quality compared to the original setup (left) [10].

The conversion of a steel casting pump housing at the Otto Junker Edelstahlgießerei, Simmerath/Germany from side risers to direct-pour top risers with filters, was only implemented because casting process simulation previously verified the feasibility and success potential of this change. Thereby, the total amount of liquid metal was reduced to 81% of the original amount. Significant savings were additionally achieved in reducing the molding time (79%), minimizing the time needed to burn of the risers (87%), and other related cleaning processes. The total production costs for the part were reduced by 12% [11].

A South American iron foundry was able to increase the casting yield for a ductile iron differential case housing from 62% to 67% by using casting process simulation to develop a non-traditional gating system. At the same time its overall scrap rate was lowered from 17% to 7%. With 24,000 parts per year, 700,000 kWh were saved, leading to a cost reduction of US\$500,000.00 [12].

### **Energy and cost savings through riser optimization**

The foundry of Heidelberger Druck AG in Amstetten/Germany this year alone has evaluated and modified the gating and process technology of 38 currently produced parts with a production volume of 32,000 castings per year. Through this effort 295 metric tons of re-melt with the total weight of 1,300 metric tons were eliminated.

Within the first 18 month Heidelberger Druck saved €100,000.00 per year on material and energy costs [13].

I.e. based on simulation results, the gating system of a gear was changed from 5 to 2 risers. This reduced the pouring weight by 69kg per part or 82 metric tons per year, saving €32.00 per part or €38,000.00 per year (Figure 4).

The use of simulation also enabled the foundry to change a 3-on mold for a bearing to a 4-on mold with a simultaneous reduction in the number of risers. The casting yield increased by 53%, reducing the cost per part by €2.18.

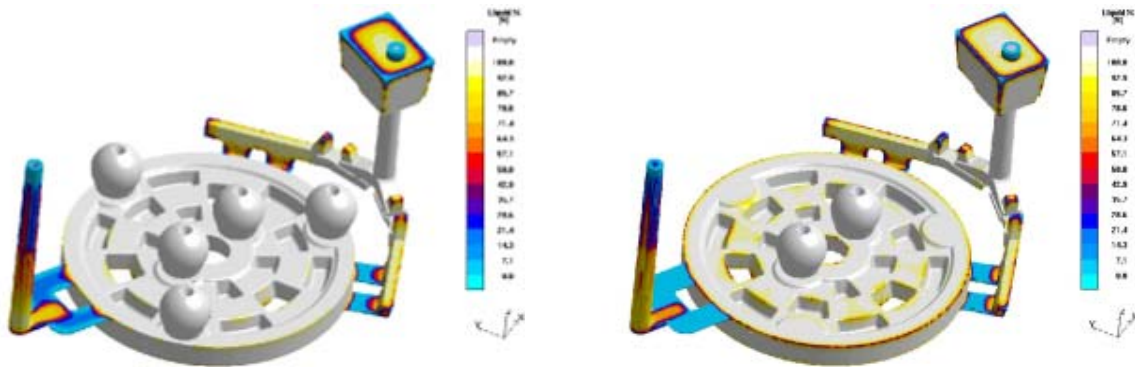

Fig. 4: The original gating system for the gear required 5 risers (left). The optimized casting technology requires only 2 risers per part (right) [13].

### **Quality supported by simulation avoids energy intensive scrap**

John Deere, Moline/IL, USA, was able to reduce the scrap rate of a gray iron part from 10.3% to 1.4% by modifying its design and gating system, leading to annual savings of US\$66,936.00 (Figure 5). At the same time, the casting yield was increased from 58% to 64% through the consequent utilization of casting process simulation. This equals additional savings of \$66,600.00 per year. The total amount of iron necessary was reduced by 195,6 metric tons leading to 274 molds more available on a molding line running at full capacity. This optimization also provides energy savings of 160,000 kWh per year. If simulation would have been used at an earlier stage, the foundry claimed an additional savings potential of US\$140,000.00

in the first year of production and the avoidance of casting design and pattern change costs of US\$120,000.00.

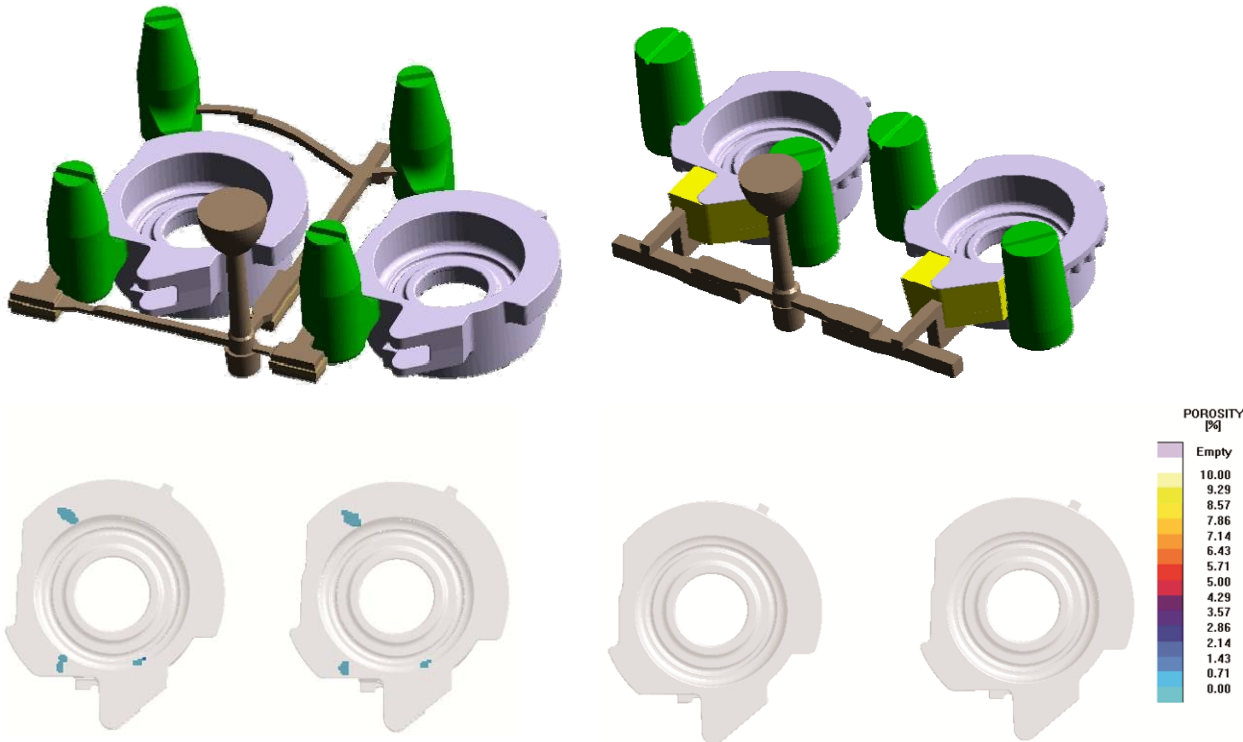
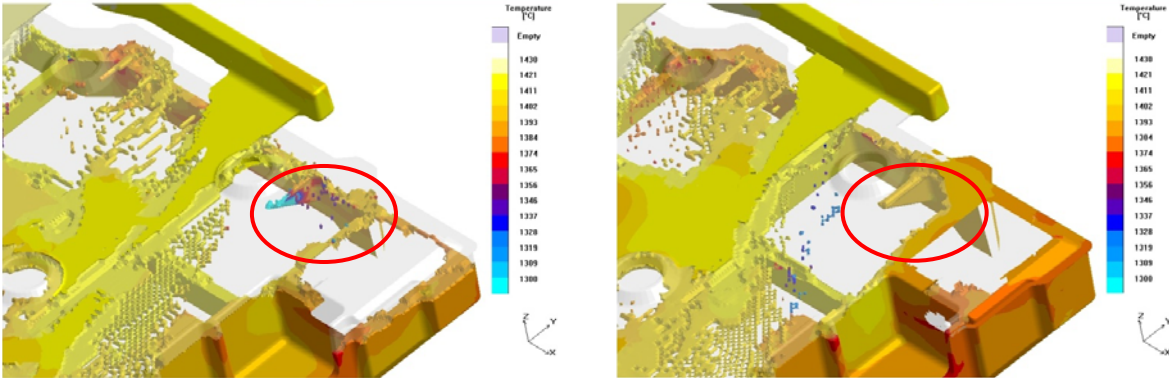

Fig. 5: Redesign of a casting and modification of gating technology for a gray iron casting lead to substantial energy and cost savings [14].

The relocation of a gate, based on an optimization conducted within casting process simulation has significantly reduced the rework necessary on a cover produced by the foundry of Heidelberger Druck AG: the temperature losses in the original part lead to an incomplete filling of a rib, requiring repair welding on 90% of the parts. The relocation of the gate eliminated any need for rework (Figure 6).



## Efficiency improvement of production and logistic costs in foundries

The prediction of solidification and cooling times for critical parts enabled Heidelberger Druck to reduce production cycle times and to optimize cooling (holding) areas and mold frame availability. Therefore, costs associated with production and logistics have been optimized (Figure 7).

Simulation allows foundry engineers to modify the gate and riser contact geometries in a way that they break off during the shakeout of bearing caps, rather than needing to having them cut off. Annual savings: €5,400.00 with a production of 12,700 parts.

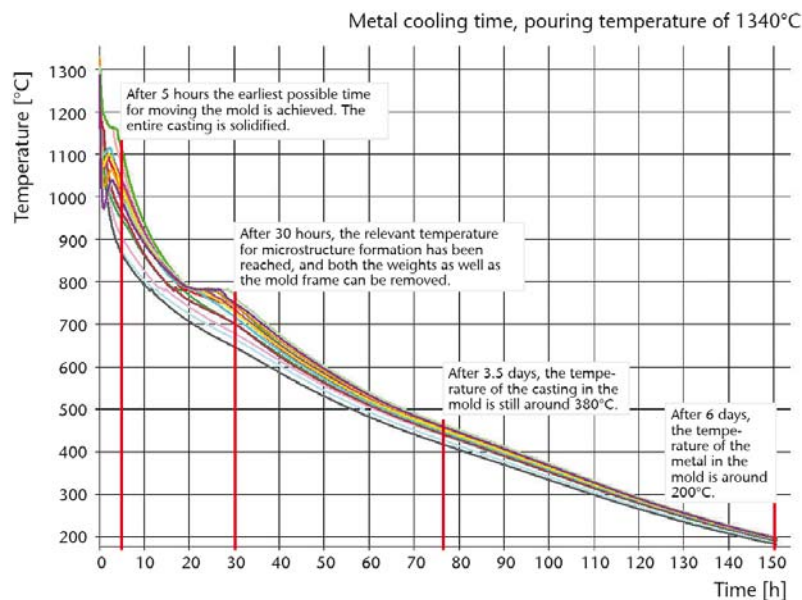

Fig. 7: Prediction of cooling times assists in optimizing the layout of foundry equipment and in reducing logistic costs [13].

## Energy savings potential through the simulation of heat treatment

Many castings achieve their final mechanical properties during the heat treatment process after the actual casting process. The optimal process layout and related energy input during the heat treatment process is strongly related to the knowledge of when a certain microstructure is established. The entire heat treatment process and resulting microstructures and mechanical properties can be simulated. Another aspect, that can be simulated, is the reduction of residual stresses. It is common to add massive safety margins to each heat treatment process step, as in the past there

was a huge amount of uncertainty attached to how heat treatment furnaces provide the energy and how that energy is transmitted into the parts. Process simulation allows the operator early on to drastically reduce such safety margins. New models even allow for the prediction of local carbon saturation in castiron and steel [15]. Given a total austenitization time for a wind energy part of 6h and a time reduction potential of 1.5h provides potential energy savings of 128 kWh per metric ton of product. For 500 heat treated parts, the savings add up to 100,000 kWh per year (Figure 8).

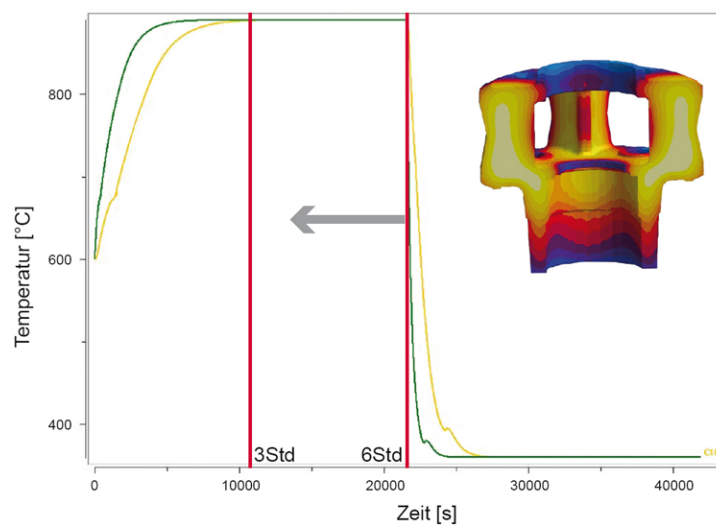

Fig. 8: Simulation assisted optimization of heat treatment process times [15].

### **Energy and cost savings in aluminum permanent mold casting processes**

The potential for energy savings in mass produced castings is comparatively high, due to the leverage provided by the huge number of parts. Unfortunately, the process related number of degrees of freedom in permanent mold applications is much lower than in sand casting processes. However, potential energy savings can be found in the entire process chain.

The original gating system for a motorcycle fork produced using the tilt pour casting process, lead to several quality issues depicted by casting process simulation. Additionally, the casting yield was only 49%.

The entirely simulation-based development of the final solution eliminated previously present turbulences during the filling process. A hotspot and related defect was eradicated as well. Smaller gates lead to an improvement of the casting yield by

18.5%. The faster filling of thin walls reduced solidification time and, thereby, cycle times by 10% (Figure 9).

The cost reduction through the utilization of casting process simulation can be calculated by considering the higher casting yield, the lower scrap rate, the shorter cycle time, and the savings in tooling and material costs. Despite the increased effort for implementing the new gating technology into the die, total saving of €28,000.00 were realized within the first year.



Fig. 9: Optimized gating system and permanent mold layout for an aluminum motorcycle fork (left: original gating layout and hotspot distribution, right: optimized gating layout with directional solidification [16]).

Through pattern layout changes and casting process modifications, only possible by utilizing casting process simulation, the aluminum foundry EBCC, Wroclaw/Poland, achieved more than €100,000.00 in cost savings in their production of brake calipers [17]. The main factors leading to this success were the reduction of burn-off during melting (about €25,000.00 per year), melting energy savings (about €45,000.00 per year), and reduced cycle time with resulting lower wear of the permanent mold lead to a reduction in the number of needed replacement molds (€35,000.00 per year). Obviously, this reduction in cycle time also lead to an increased productivity (Figures 10 and 11).

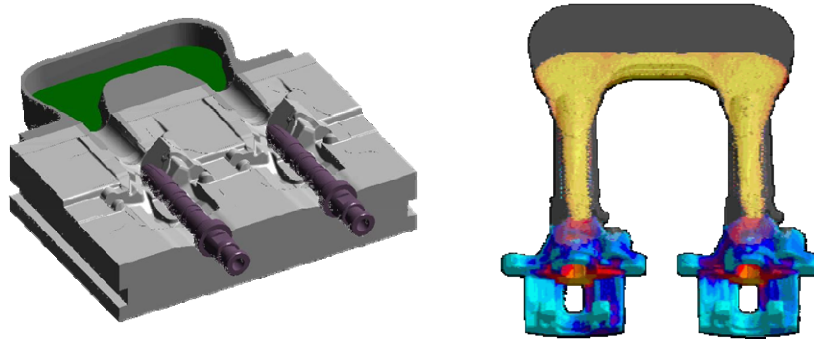

Fig. 10: Mold layout and simulation of the tilting process of a brake caliper [17].

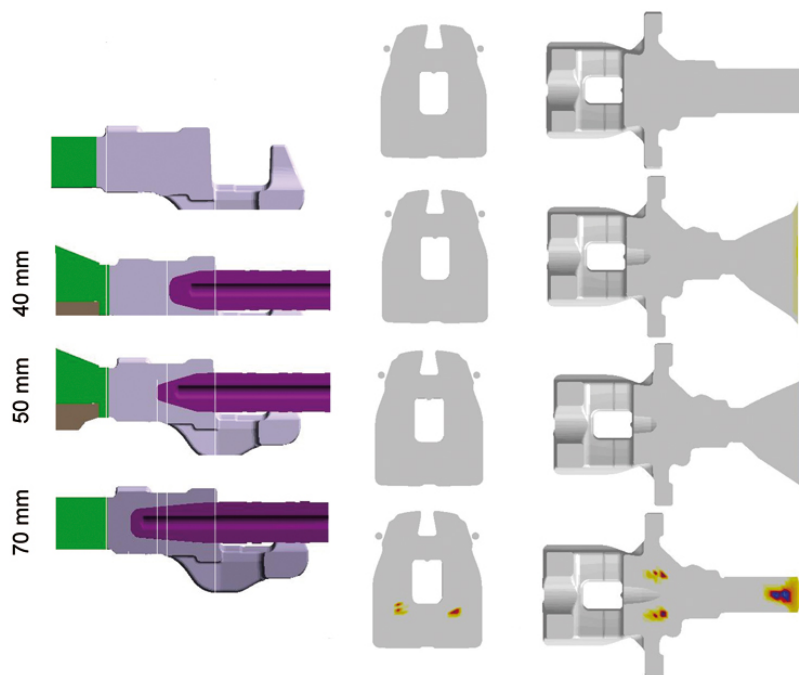

Figure 11: Optimization of mold and riser geometries lead to robust process conditions and simultaneous reduction in energy input.

### Savings potential in high pressure diecasting

In high pressure diecasting processes 40% to 60% of the entire energy requirement is used to provide the liquid metal. The remainder is used for the actual casting process [18]. The energy input required for the melting process is dependent on the amount of scrap (typically 5 to 7%) and melting losses (2 to 5%), as well as is significantly impacted by the ratio between casting weight and total pouring weight (casting yield), which ranges, depending on the particular part and process used, between 30 and 70%. Hereby, also dependent on the foundry equipment differences between foundries and their individual efforts to increase energy efficiencies, the

amount of natural gas used for melting can vary by a factor of 7 and the amount of electricity used can vary by a factor of 2, leading to an average value of 5,603 kWh per metric ton of final castings [2]. These numbers show the potential lying in optimized gating systems and their impact on potential energy savings.

It is typical for the actual high pressure diecasting process that a large amount of energy is lost through cooling and energy transferred to the environment, so only a small part of the energy remains within the casting. Additional potential for energy efficiency improvements are hiding in the die layout (i.e. productivity increase through multi-cavity dies) and dielife extension (increased utilization of provided primary energy and use of materials per produced part).

A thorough optimization of the entire production process can add up to energy savings of 15 to 35% achievable by any diecaster (Figure 12) [2]. Casting process simulation can provide significant contributions, as it is being evaluated in a current research project [18].

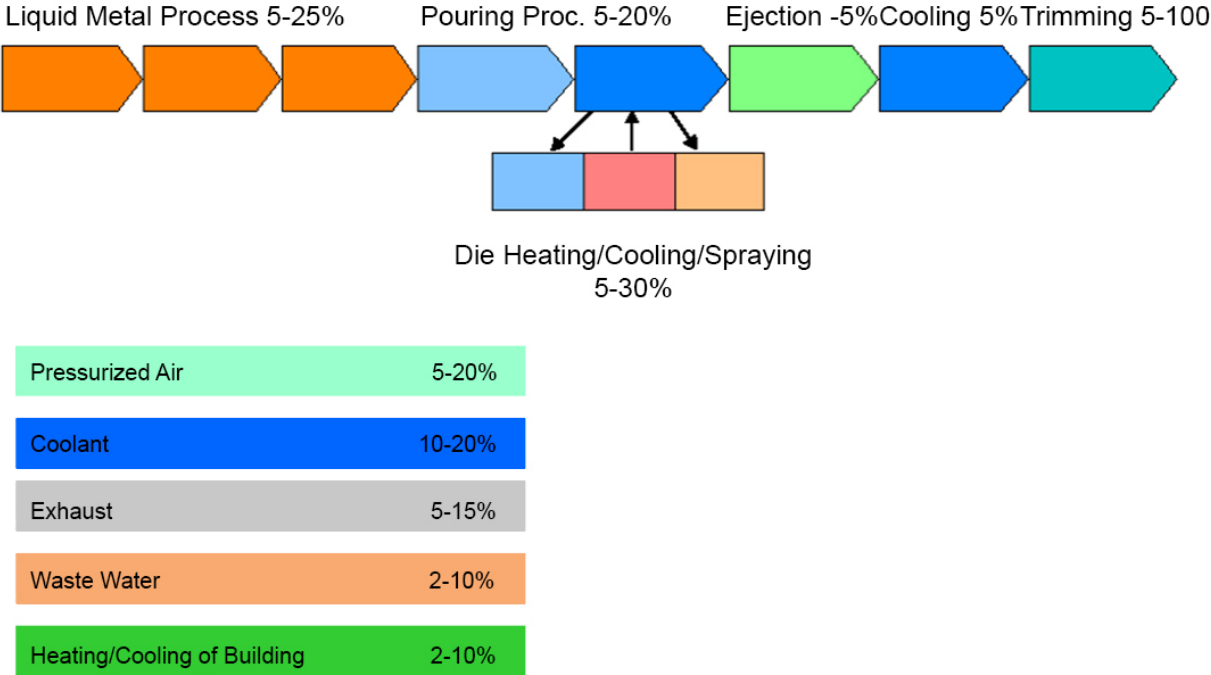

Fig. 12: Energy savings potential in high pressure diecasting processes by process step [2].



## Optimization of gating systems and re-melt

Using a gearbox-housing as an example, a research project evaluated the energy savings potential of switching an oil-based die cooling system to a water-based one. The condition was not to negatively impact the casting quality. A comprehensive virtual parameter study (DoE) was conducted using casting process simulation to evaluate the impact of several process parameters and gating designs (Figure 13). The software allows for the immediate comparison of all calculated trial runs and depicts the best solutions (Figure 14).

The result was a reduction of runner volume by 25%, which lead to 12% less material used per shot. At the same time, the optimized cooling line design, in combination with the lower pouring weight, lead to a cycle time reduction of 8% [19].

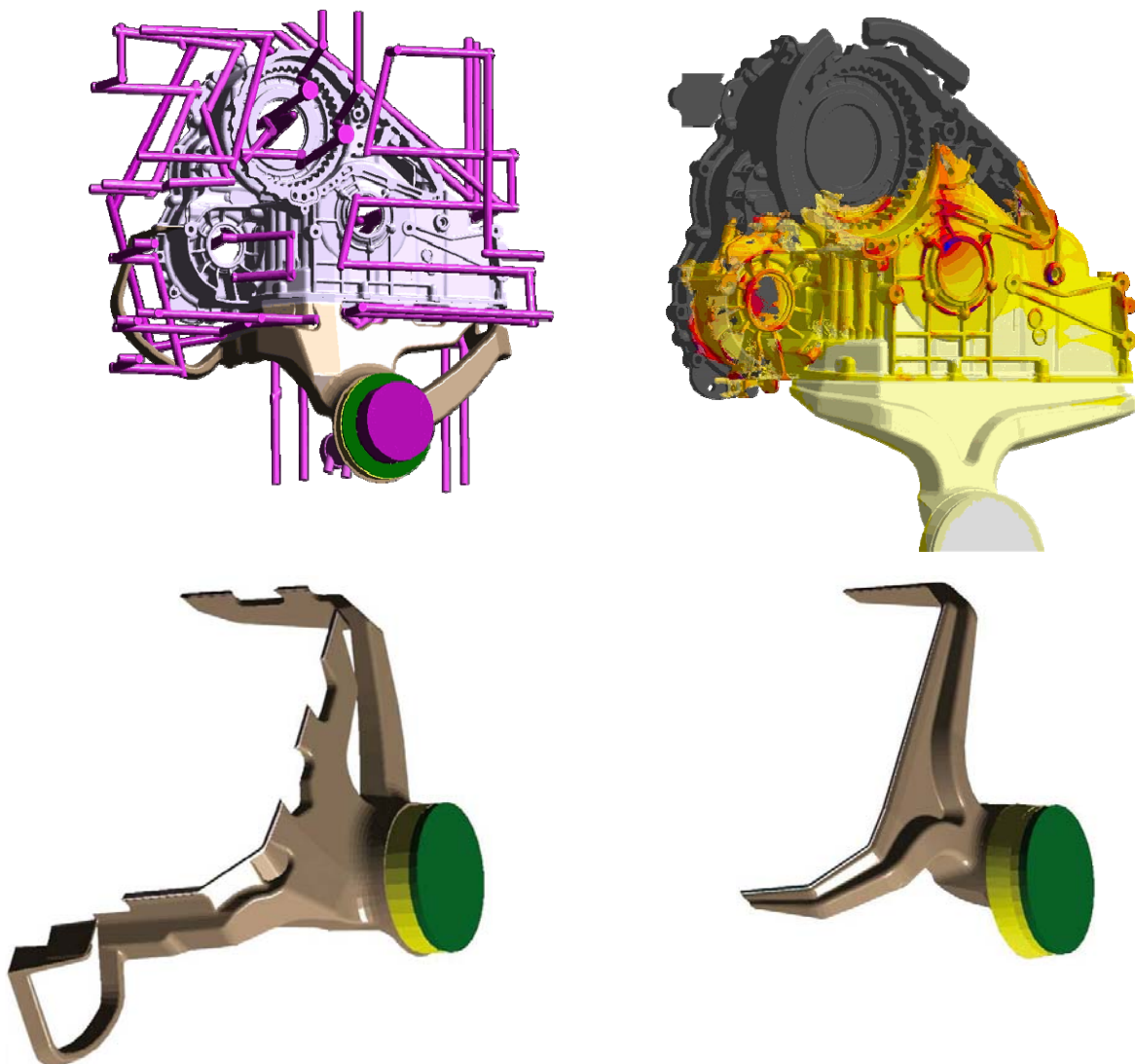

Fig. 13: Optimized gating layout of a gearbox housing, upper right: Original layout and cooling line design, upper left: the optimized runner results in a homogeneous filling pattern, original (lower left) and weight optimized runner system (lower right) [19].

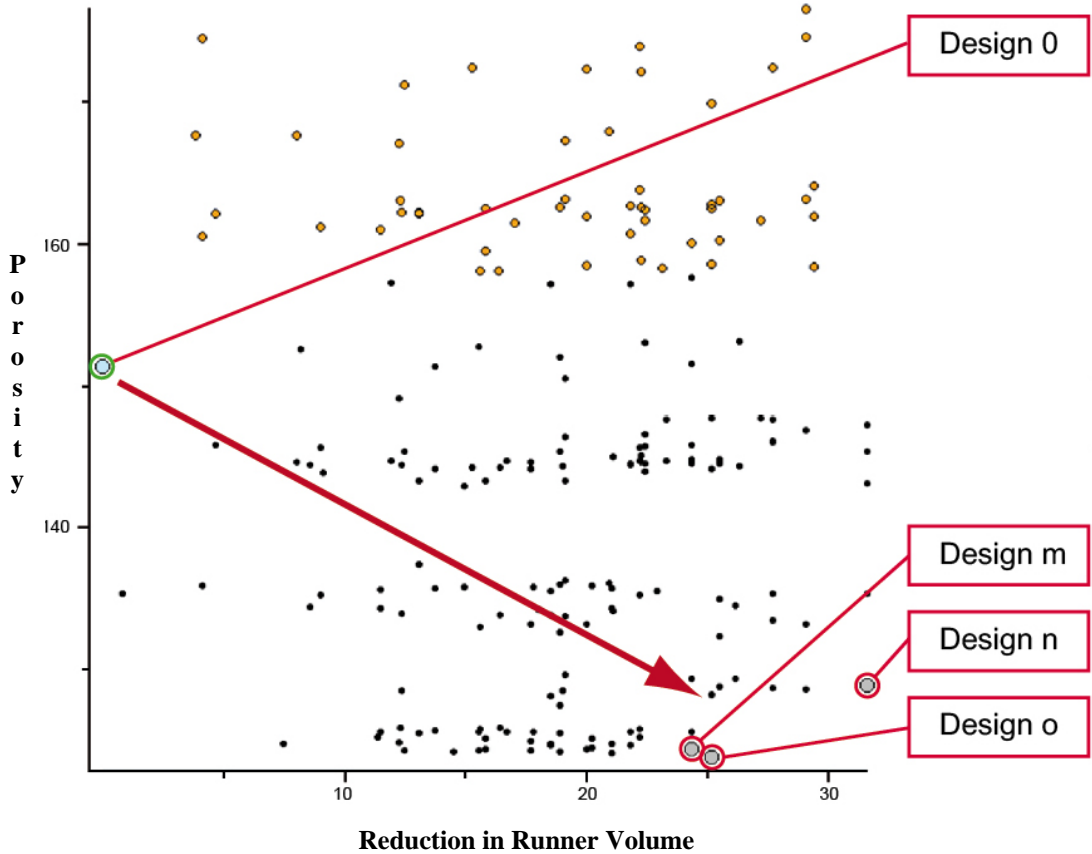

Fig.14: Automatic optimization of casting process and die temperature through casting process simulation. The parameter study of different designs shows, that there are solutions (designs m, n and o) that provide reduced runner volume in combination with improved casting quality, compared to the original setup (design 0) [20].

**Dielife Improvement**

Thermo-mechanical fatigue of diecast dies and abrasive wear in their runner systems are the main reasons for die failures. The correlated costs are enormous: typical replacement costs for a die insert are approx. €50,000.00, not counting the cost for down time of the diecasting machine of approx. €3,000.00 per day. Through casting

process simulation critical locations for heat checking and wear can nowadays be identified very reliably (Figure 15). Modifications of process parameters, design changes on the die, and improved die materials can prevent these problems.

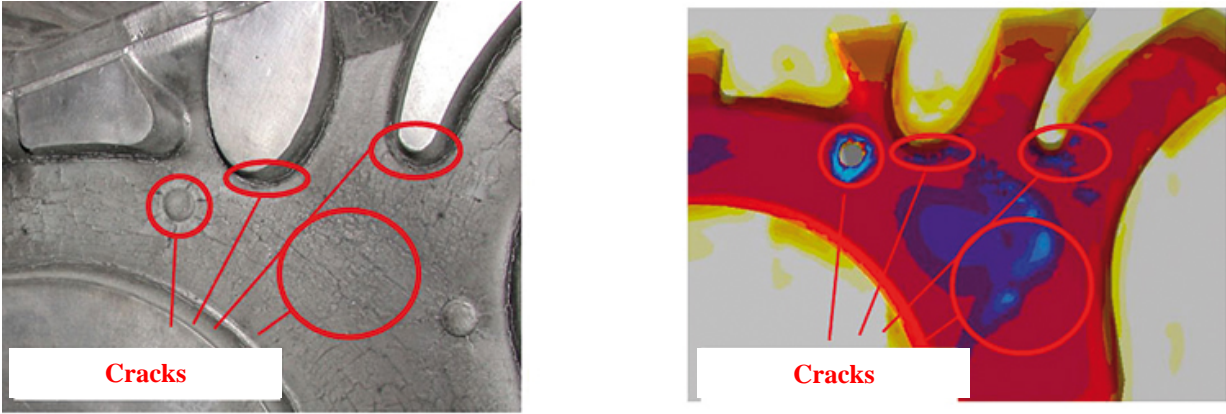

Fig.15: Prediction of dielife through simulation of local thermo-mechanical fatigue [21]

At Metallgießerei Karl Scherb GmbH, Dietenheim/Germany, the change of the gating system with the goal to reduce previously experienced high die wear and related pour dielife lead to cost savings of €25,000.00 (Figure 16). €20,000.00 less were needed to be paid for testing and pressure testing equipment, as also the porosity distribution in the casting was improved [22].

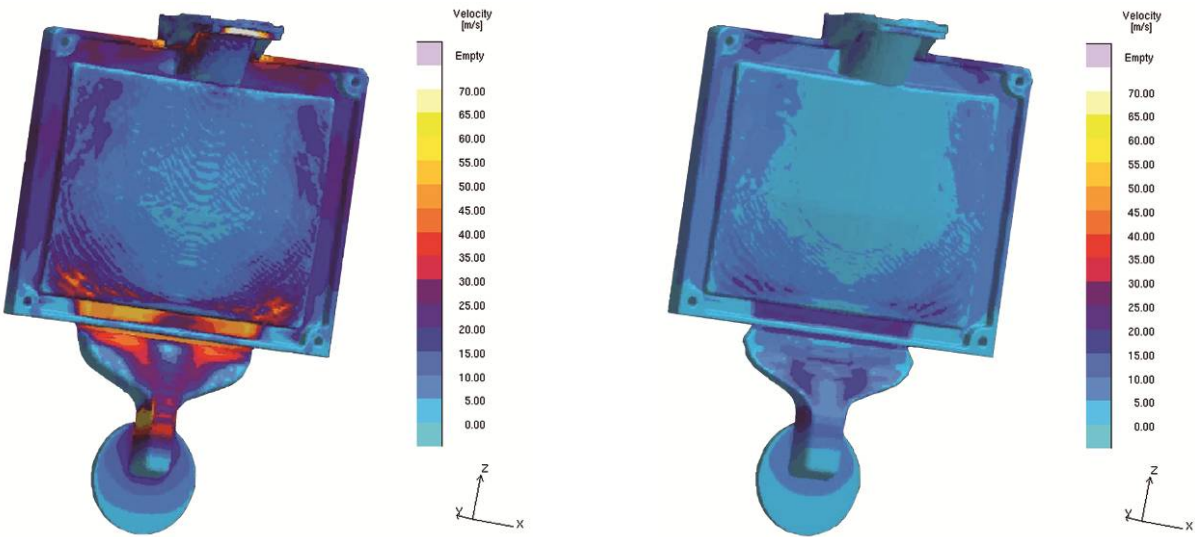

Fig. 16: Lowering the gate velocity improved the dielife of the die insert [22].

## Efficiency improvement and cost reduction through multi-cavity dies

It is true for all casting processes that the productivity and correlated specific energy and material consumption are dependent on the number of poured castings per mold or die. This is especially true in the high pressure diecasting process where the challenges related to production technology and casting quality increase exponentially with the rising number of part cavities. By using a two-cavity die it is possible to reduce costs by 20 to 40% compared to a single cavity die (Figure 17). Besides related maintenance costs, the biggest potential for cost reduction on a per part basis can be found in the energy savings in running the equipment [23]. None of the traditionally used steps to improve the process of a single cavity die can achieve a comparable productivity improvement.

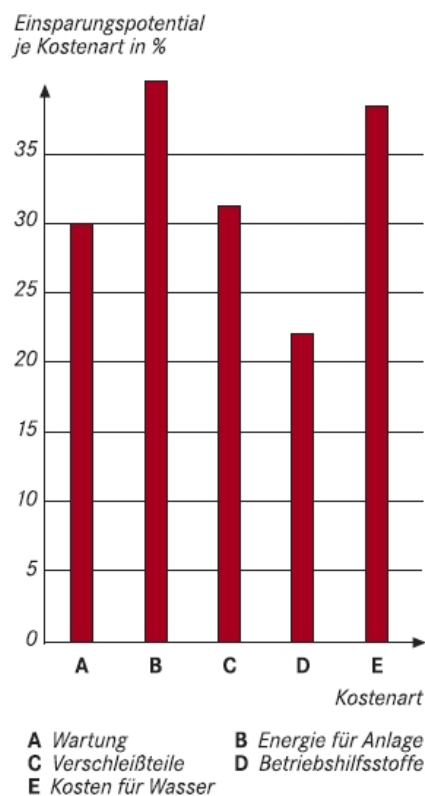

Fig. 17: Savings potential comparing a single cavity die to a dual cavity die. Depending on the cost category 20 to 40% can be eliminated [23].

Unfortunately, the production risk increases tremendously when the number of cavities is increased. Therefore, the process needs to be controlled reliably. The

change from a single to a multi-cavity die requires the change of the runner design, which often can lead to quality differences between the castings in the die. This problem is especially present in dies using a non-symmetrical gating system, where the separate cavities are fed by individual runners. Designing a flow-dependent shape of the runners, the filling characteristics of a single-cavity die were successfully transferred to a dual-cavity die (Figure 18). The high quality level achieved in the single-cavity die, were successfully transferred to a dual-cavity setup by utilizing automatic optimization. The production risk was thereby significantly reduced through the use of casting process simulation and the foundry benefited immediately from the implementation of the new layout.

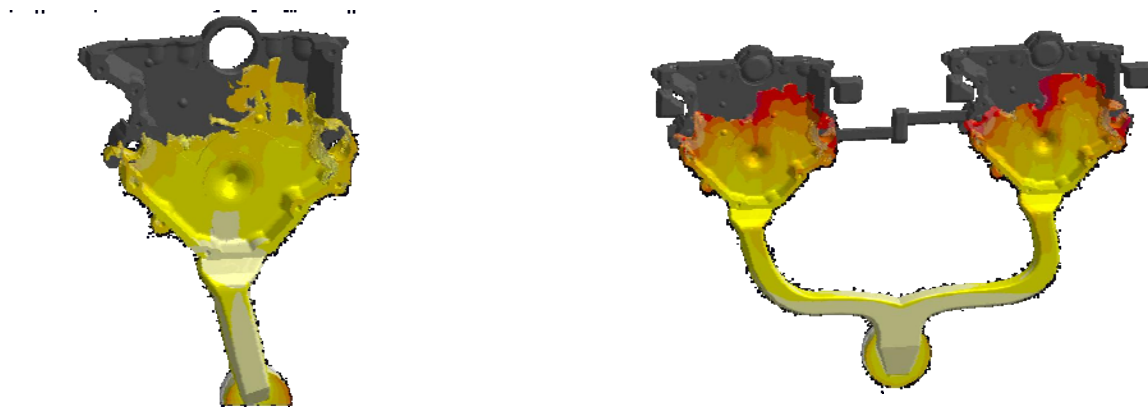

Fig. 18: Transfer of proven filling pattern to a dual-cavity die [23].

The tool manufacturer Metabo International GmbH, Nürtingen/Germany makes about 2 Mio castings per year. As decorative parts, gear boxes and gears, they provide the, “massive” core of their power tools. Casting process simulation allows their engineers to create multi-cavity dies bordering on the physically impossible. Through the optimization of their runner systems over the last years Metabo was able to reduce their re-melt material by 50%. This had an immediate impact on energy used for melting, heating, material logistic and transport [24].

Overall, the costs per part were reduced by 40% through the use of multi-cavity dies, increased dielife and reduced costs for re-circulating material (re-melt) – a cost reduction Metabo relates directly to casting process simulation.

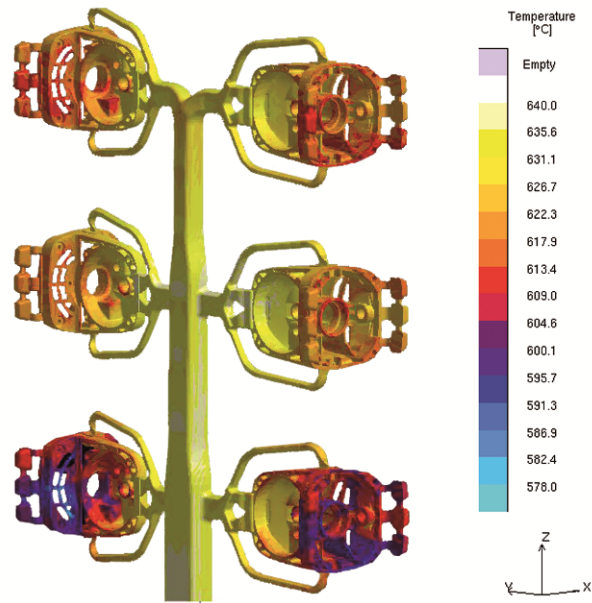

Fig. 19: The utilization of multi-cavity dies requires, especially in combination with complex parts, early and reliable information provided by casting process simulation [24].

### Energy savings through conversions to castings

There is a completely different area where casting process simulation contributes to energy savings. In competition with other manufacturing processes, casting is the most direct route to a near-net-shape product. Through the utilization of closed-looped processes, the casting process has energy related advantages compared to machining processes or welding. Each ton of castings uses only two thirds of the primary energy needed for machined parts. Current simulation technology provides the opportunity to convert fabricated parts into complex, near-net-shape castings. This is true for entire parts, as well as small elements used in assemblies. One example is the company Metabo that includes pre-cast drill holes in their parts, avoiding the machining process to drill them, after assuring the feasibility by using simulation (Figure 19). The few pennies it saves per part to cast in these features and the elimination of subsequent machining processes add up to several hundred thousand Euros per year of savings.

The potential of conversions is also shown in the following example from the equipment manufacturing industry: a large gearbox housing (Figure 20) fabricated by

welding plates together was converted to a ductile iron casting. The process included the utilization of topology optimization and casting process simulation in parallel, to assure a design fulfilling the application load requirements (primarily rigidity), as well as casting process related requirements. The result of the collaboration of designers and foundry engineers was a three-part gearbox made of ductile iron, achieving a higher rigidity than the original welded part. At the same time the final weight of the part was reduced to 18.4 metric tons, a reduction of 20%. As the cost of such parts is strongly correlated to material costs, the weight reduction lead also to a price reduction [25].

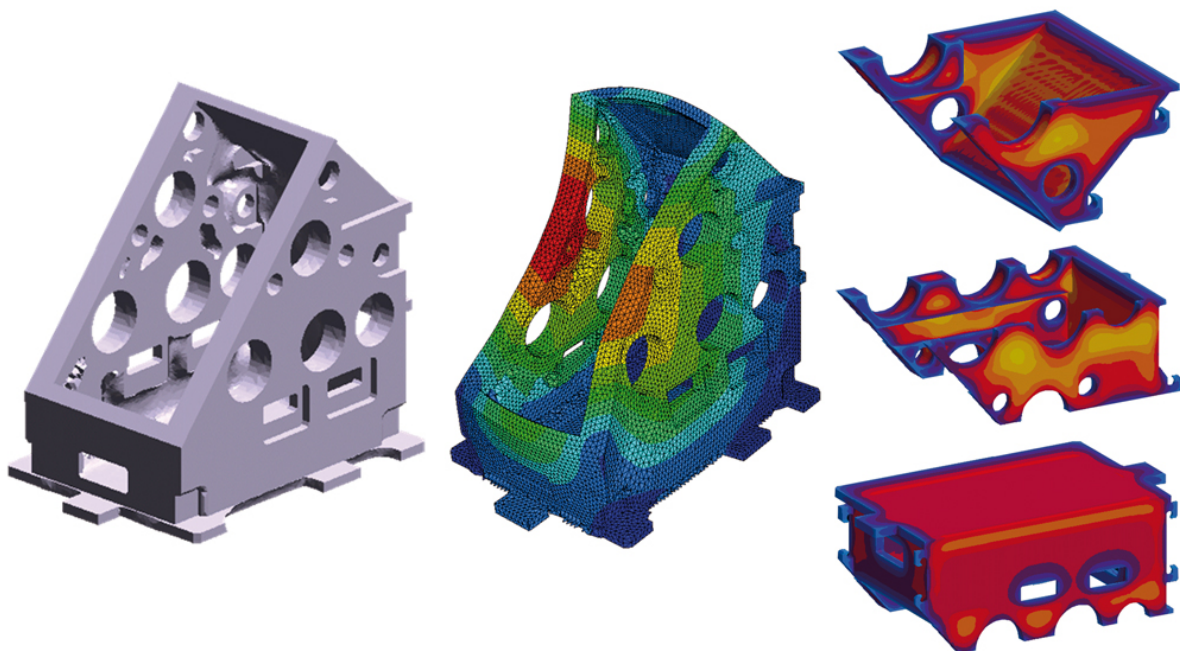

Fig. 20: Conversion of a large gearbox to a casting. Only the thorough utilization of simulation (left: topology optimization, center: load simulation, right: casting process simulation of the three castings) achieves a weight reduction of 20% compared with the welded part [25].

### **Casting Process Simulation – from competitive advantage to technology saving the environment**

In many foundries casting process simulation is an established standard technology to reduce costs and assure robust processes. Casting buyers in automotive and equipment manufacturing industries increasingly demand from their suppliers to

provide simulation-approved, robust, and energy conserving production processes and castings. The energy and climate protection related goals of the European Union require an improvement in energy efficiency of 20% by the year 2020 [26]. The provided examples documenting that, if casting process simulation is utilized throughout the entire casting and related processes, a 10% efficiency improvement is easily accomplishable. This equals a savings potential, just for the German foundry industry, of up to 1 billion kWh or 560,000 metric tons of CO<sub>2</sub> per year. In connection with the current discussion relating to energy efficiency and related protection of the environment, the displayed potential savings in energy and materials, achievable through the utilization of casting process simulation, make the use of simulation in foundries mandatory.



## Literature

- [1] „Energieeffizienter Gießereibetrieb“ 2010, Herausgeber: Bundesverband der Deutschen Gießerei-Industrie (BDG)
- [2] Jordi, U.: „Energie-Sparpotenziale im Druckguss“, Energieeffizienztagung, Frankfurt (2010)
- [3] Jahresbericht 2008 des Bundesverbands der Deutschen Gießerei-Industrie (BDG)
- [4] Quelle Umweltbundesamt, <http://www.umweltbundesamt.de/energie/archiv/co2-strommix.pdf>
- [5] Sturm, J.C.: „Optimierung des Feingußverfahrens durch den Einsatz moderner Simulationstechniken“ VDI Verlag, Reihe 5: Grund- und Werkstoffe, Nr. 226 ISBN 3-18-14 2605-9
- [6] M. Fehlbier, J. Lerch-Thies, H.-I. Stanescu: „Entwicklung dünnwandiger Strukturbauteile mit Hilfe numerischer Simulationsmethoden“, 6. Magma NE- und Leichtmetallforum (2010), Ludwigsburg
- [7] Egner-Walter, A. Zenker. N. und Fritsche, E.: „Vorhersage von Gefüge und lokalen Eigenschaften für Kurbelgehäuse aus GJV, VDI-Fachtagung: Gießtechnik im Motorenbau, Magdeburg (2011).
- [8] entnommen aus Vortrag Magma Nord-Amerikanisches Anwendertreffen 2009
- [9] entnommen aus Vortrag Magma Nord-Amerikanisches Anwendertreffen 2009
- [10] entnommen aus „At the Heart of Casting - Mitten im Guss“ Herausgeber: Magma GmbH, 2008
- [11] Schreiner, J. Pfisterer, W.: „Der Einsatz der numerischen Simulation zur Wirtschaftlichen Auslegung der Gießtechnik am Beispiel eines Edelstahlgussteiles“, Vortrag auf 8. VDI-Tagung in Veithöchheim, 1995
- [12] persönliche Mitteilung
- [13] Giesen, H.: „Qualitätsguss entsteht auf dem Bildschirm“, Industrieanzeiger, Ausgabe 02/2011, 32-34
- [14] Barter. D., John Deere Waterloo Foundry: „Using Magmasoft to Design Cost Effective and More Manufacturable Castings“, Vortrag auf dem Magma Nord-Amerikanischen Anwendertreffen 2009
- [15] Sturm, J. C. und Busch, G: „Cast Iron - a predictable material“, Proceedings of World Foundry Congress 2010, Hangzhou, China
- [16] „Kleine Änderungen, große Wirkung“ Magmatimes 01/2008, S. 1-2

- [17] Targowski, W. (EBCC Poland) et. al: "Implementation of Magmasoft to improve a gravity die casting process on an example of aluminum disc brake calipers manufacturing, Vortrag auf dem Internationalen Magma-Anwendertreffen (2006), Kopenhagen/Oslo.
- [18] Pries, H.: „Progresse – Ansätze zur Erhöhung der Energie- und Ressourceneffizienz in der Prozesskette Aluminium-Druckguss“, Energieeffizienztagung, Frankfurt (2010)
- [19] Hartmann, G.: Vortrag auf Progress-Treffen, Gestaltung ressourceneffizienter Prozessketten am Beispiel Aluminium-Druckguss, BMBF-Verbundforschungsvorhaben, Karlsruhe 2009
- [20] R. Seefeldt, Vortrag auf Progress-Treffen, Gestaltung ressourceneffizienter Prozessketten am Beispiel Aluminium-Druckguss, BMBF-Verbundforschungsvorhaben, Hildesheim 2011
- [21] Egner-Walter, A. und Olive, S: "Using Stress Simulation to tackle Distortion and Cracking in Castings", World Foundry Congress 2006, Harrogate, England, Juni 06
- [22] Bärman, F.: „Breitere Service-Palette, rationelle Produktion“, Produktion, Ausgabe 10/2011, 24
- [23] R. Seefeld, J. Sturm und A. Pawlowski: „Aus Eins mach Zwei“, GIESSEREI 94 (2007), Ausgabe 4, 34–42. Giesserei-Verlag GmbH, Düsseldorf
- [24] „Sichere Qualität durch Prozesssimulation“, Produktion, Ausgabe 31-32/2010, 16
- [25] Schulz, R.; Amato, R.; Egner-Walter; A; Busch G.; Zimmermann, J.: "Von der Schweißkonstruktion zum Gussteil – Topologieoptimierung und Gießsimulation für ein Getriebegehäuse", Vortrag auf dem 4. Magma-Eisengussseminar 2006, Heilbronn
- [26] Information entnommen aus Schumacher, M: „Energie(-effizienz) – Ein Schlüsselthema für die Gießerei-Industrie“, GIESSEREI 98, 04/2011, 68-72